



## Master-PROTECT Pipe-Bends & Pipes

Innovative Wear Protection - Long-Lasting & Reliable



# Master-PROTECT

## Long service life with optimum flow & operating characteristics

A production plant depends heavily on the reliability of its pneumatic conveyor systems. Time and again, pipe-bends especially susceptible to wear cause production downtimes.

Uncalculated production downtimes rapidly increase operating costs. These result in far greater repair and maintenance costs coupled with a reduction in productivity.

Masterflex offers a proven and complete solution, which consists of steel pipe-bends with PU lining. The material PU provides a significantly greater wear-resistance than almost any other material used in this field. Thanks to the combination of the robust PU lining and the patented geometrical arrangement of the plastic, excellent results are achieved and guaranteed. In comparison to traditional methods, the life cycles of pipe systems can be drastically increased.

Standard Pipe-Bend

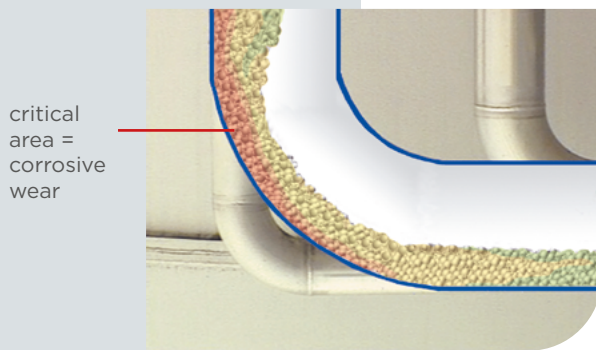

Master-PROTECT Pipe-Bend

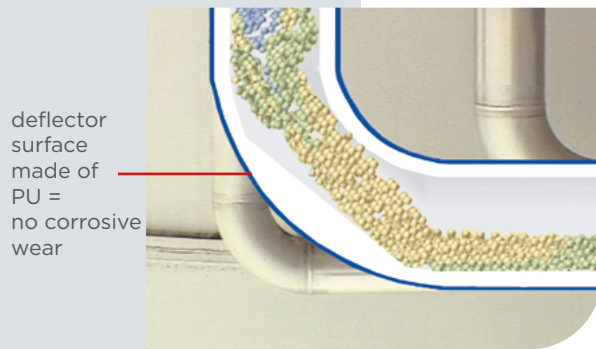

### How it works:

Thanks to the combination of extremely tough polyurethane and a uniquely modified inner geometry, in contrast to standardised pipe-bends, the revolutionary **Master-PROTECT** counteracts the so-called impact wear, which is a frequent occurrence in the use of pipe-bends.

The transported media impacts on the PU deflector surface so that no corrosive wear is possible (see left). Much like a trampoline, the bulk solids are cushioned and propelled diagonally through the bend, meaning that virtually no transport speed is lost along the way.

The inner geometry of the pipe-bend means that even stubborn strands of bulk solids detach themselves from the inner walls during the wear-critical lean phase. This causes the concentration of the material to be distributed more evenly across the cross-section of the pipe. Directly after the pipe-bend, a constant speed profile is once again achieved within a very short distance, meaning the piping after the bend is only exposed to greatly reduced loads.



## In short:

The speciality of the **Master-PROTECT** pipe-bend is the combination of material and patented form



# Master-PROTECT Assembly Set

## A Compatible System for All Plants

Master-PROTECT pipe-bends can be seamlessly integrated into existing plant systems without the need for any constructional changes.

Problem-free application of:

- Pipe-bends with a larger bend radius
- Conventional wear-protection pipe-bends

Masterflex supplies standard connection sizes with fixed flanges (PN6, PN10/16) and standardised inner dimensions (DN 50 - DN 200) acc. to DIN 2448, which enable a seamless joining of the PU lining to the piping.

### Application Example

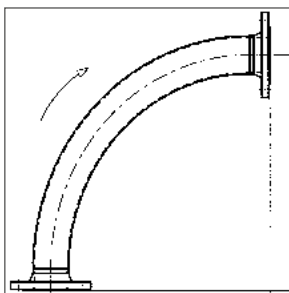

Before

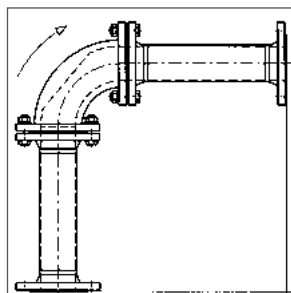

After

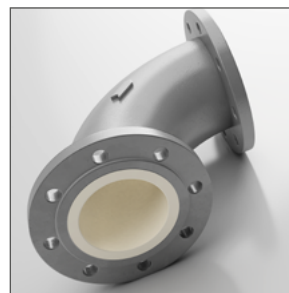

Master-PROTECT Pipe-Bend

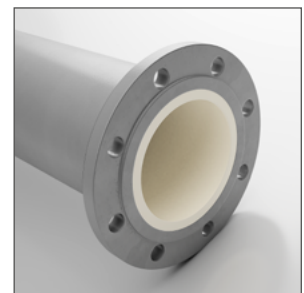

Master-PROTECT Pipe

### Product Advantages:

- No material residue
- Extremely abrasion-resistant
- Longer life cycles
- Excellent corrosion protection
- No caking
- Low net weight
- Installation in existing pipe system possible
- No interference with transport media
- Significantly fewer pressure drops

### Product Benefits:

- Longer service life
- Greater reliability
- Lower energy costs
- Shorter cleaning & empty running times
- Greater transportation speeds
- Short installation times
- Significantly reduced downtimes

### Your Benefits:

- Greater equipment availability
- Increased productivity
- Lower operating costs

### Result:

- Significantly improved cost-efficiency

Tests carried out by the Technical University of Braunschweig confirm the product benefits of the unique bend geometry

- greater particle speeds compared to standard pipe-bends
- significantly fewer pressure drops than in conventional parts
- reduced risk of blockage due to the concentration of the material being distributed evenly and at a constant speed



# Master-PROTECT Pipe-Bends

| DN  | d   | PN= Pressure Stage | A= Side Length mm | D= Flange Outer-Ø | k= Hole Circle | No. Holes | Article No. |
|-----|-----|--------------------|-------------------|-------------------|----------------|-----------|-------------|
| 40  | 43  | 10/16              | 99                | 150               | 110            | 4         | 004107      |
| 50  | 54  | 10/16              | 121               | 165               | 125            | 4         | 004108      |
| 65  | 70  | 6                  | 133               | 160               | 130            | 4         | 004110      |
| 65  | 70  | 10/16              | 140               | 185               | 145            | 4         | 004111      |
| 80  | 82  | 6                  | 157               | 190               | 150            | 4         | 004112      |
| 80  | 82  | 10/16              | 165               | 200               | 160            | 8         | 004113      |
| 100 | 107 | 6                  | 198               | 210               | 170            | 4         | 004118      |
| 100 | 107 | 10/16              | 205               | 220               | 180            | 8         | 004119      |
| 125 | 131 | 10/16              | 246               | 250               | 210            | 8         | 004123      |
| 150 | 159 | 10/16              | 284               | 285               | 240            | 8         | 004124      |
| 200 | 207 | 6                  | 360               | 320               | 280            | 8         | 004126      |

All data refers to a medium and ambient temperature of +20 °C.  
 \* Refers to the inner hose lining.  
 Subject to technical changes and colour deviations.

## Material

Lining: Polyurethane

Bend: DIN 2448, Material 1.0255, primed

Flange: Material 1.0038, primed

Also available in stainless steel

## Applications

- Pneumatic conveying plants
- Quartz sand, foundries, chemicals, plastics, construction materials

## Properties

- extremely abrasion-resistant
- significantly lower pressure loss as in deflection/ impact absorbers
- reduced operating costs via longer maintenance intervals
- lower risk of blockages via uniform concentration distribution and a more constant speed of transported goods
- much greater wear-resistance than steel pipe-bends
- pressure level PN 6 and PN 10/16
- no displacement of transport media

## Temperature Range

- -40 °C to +80 °C

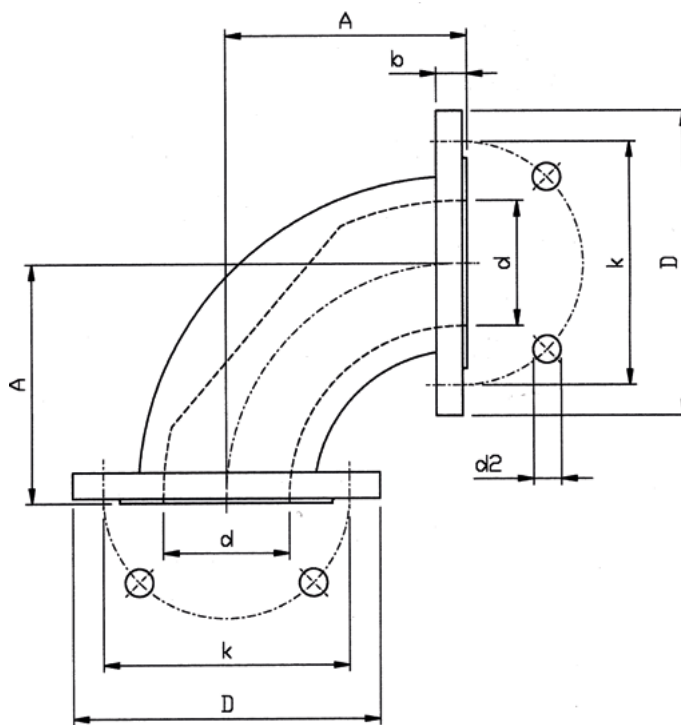

K, D, d2, b= Dimensions acc. to DIN 2632 and 2633

Technical data on PU-lined  
 Master-PROTECT pipes on request

Masterflex SE  
 Willy-Brandt-Allee 300  
 45891 Gelsenkirchen  
 Germany  
 Tel. +49 209 97077-0  
 Fax +49 209 97077-33  
 www.Masterflex.de  
 info.Masterflex@MasterflexGroup.com

A MASTERFLEX GROUP COMPANY

All rights, changes and errors reserved

 **MASTERFLEX**  
 Connecting Values